

# RepRap Industrial v1 - Manual



 RepRap Industrial v1

## General

Welcome to the RepRap Industrial 3D printer operating manual of the Jonas Kühling & Simon Kühling GbR (in the following referred to as *Kühling&Kühling*).

The RepRap Industrial 3D printer (in the following referred to as *RepRap Industrial, 3D printer or apparatus*) is a fully automatic stand-alone device for **Fused-Filament-Fabrication (FFF)** in a lab or commercial environment.

Any information needed for [installing and commissioning](#), [operating](#), [troubleshooting](#), [maintenance and repair](#) of the 3D printer are described in the following paragraphs and the accompanying sites. This user's manual must be read thoroughly as it is meant to provide the operator with all information needed to operate the RepRap Industrial safely and reasonably. Please always provide access to the website for any user of the 3D printer in case of questions or problems.

## INFO



The RepRap Industrial 3D printer is an Open Source project. Any alteration, structural and design changes or customization for test reasons, optimization and improvement are explicitly requested by Kühling&Kühling. We would like to support you with your advancements and are looking forward to receiving your feedback. We will always consider letting your achievements slip in to constantly improve the RepRap Industrial. However, please note that Kühling&Kühling cannot be held liable for damages and injuries resulting from such alterations (see [Intended use](#) also).

## Valid Version

### Hardware revisions

Number of revision	from	until
v1.3.x	04-2015	current
v1.2.x	12-2014	04-2015
v1.1.x	09-2014	12-2014
v1.0.x	02-2014	09-2014

The type plate on the of the RepRap Industrial's [rear side](#) you find all information to precisely identify your 3D printer:

- Serial number
- Date of manufacturing
- Hardware Revision<sup>1</sup>

<sup>1</sup> Starting with version **1.1.0** of the [operating software RepRapOnRails](#) you will also find the valid hardware revision in the [\[Setup\]](#) menu on the touchscreen.



Type plate on the rear side.

## Software versions

Operating software:

RepRapOnRails Version v1.3.1 → [Operating manual](#)

RepRapOnRails Version v1.1.0 → [Operating manual](#)

RepRapOnRails Version v1.0.5 → [Operating manual \(English only\)](#)

[How do I find the correct software version?](#)

## Intended use

The RepRap Industrial 3D printer has been designed and built for printing three-dimensional workpieces of nearly random geometries from common 2.85 mm thermoplastic filament strands. The apparatus is optimized for extruding **A**crylonitrile **B**utadiene **S**tylene (ABS) and its thermal and mechanical properties and with this material will achieve the stated precision and quality best. Using different thermoplastics is possible, please [contact Kühling&Kühling](#) or refer to [materials](#) for detailed information on applicable materials.

The RepRap Industrial is intended for industrial and commercial use. It is not valid for the operation in an explosive atmosphere.

Observing this manual and adhering to the stated information is part of the proper operation.

Improper operation of the RepRap Industrial can lead to hazardous situations.

It is forbidden to operate the 3D printer under conditions and for purposes other than stated in this manual.

Operating the RepRap Industrial is forbidden under the following circumstances:

- The RepRap Industrial is used for a purpose not designated.
- The RepRap Industrial or single parts are damaged, the electrical equipment has been installed improperly, or the isolation is defective.
- The RepRap Industrial does not function flawlessly.
- Mechanical components or the control system have been inexpertly altered or reconstructed.
- Operating parameters have been altered inadmissibly.
- Operation with unspecified materials.
- Use of unspecified tools.
- Failure to regularly perform the prescribed maintenance work.
- Operation in an explosive atmosphere.

## Warranty terms

The general [terms and conditions](#) of Jonas Kühling & Simon Kühling GbR apply. The customer is familiar with these terms latest on the day of signing the purchase contract.

The warranty terms and the liability period can be found in the contract documents and in the order confirmation.

Warranty claims and liability are voided in one or more of the following applies:

- unintended usage of the RepRap Industrial
- false setup, commissioning, operation repair or maintenance
- operating the apparatus with defective, missing, improperly installed and/or malfunctioning equipment.



### INFO

*Any unintended use or structural alteration of the RepRap Industrial not agreed upon with and approved in writing by Kühling&Kühling*

- unauthorized or inadmissible alteration of the electrical or mechanical equipment or the operating parameters of the apparatus.
- use of other than the specified replacement parts, tools, and/or operating materials
- exceeding the specified maintenance intervals
- cases of disaster and force majeure



*render the warranty and the EU Declaration of Conformity void and free Kühling&Kühling from product liability. Even if approved, alterations have to be carried out by the customer thoroughly and properly. If necessary, adequate safety devices have to be installed.*

## Ordering wear and spare parts and material

Wear parts must meet the technical specifications defined by *Kühling&Kühling*. *Kühling&Kühling* original parts are subject to rigid requirements and meet these standards. A complete list of available wear and spare parts and suppliable materials can be found at [our web shop](#) together with an order form.

## Life cycle

Find everything you need to know after you ordered your RepRap Industrial 3D printer in the following paragraphs. From the day of your invoice until the day you want to dispose of the apparatus and anything in between is explained here.

## Delivery

The RepRap Industrial 3D printer arrives at your place fully assembled and can be [commissioned](#) directly after setting it up and connecting the power supply.

The 3D printer is delivered in a wooden transport box on a palette. It is advisable to leave the RepRap Industrial packed and on the palette until moving it to its final installation site for commissioning.

At the installation site, unpack the RepRap Industrial according to the information in the accompanying [Quick Start Guide](#).

Dispose of the packaging in accordance with the local waste disposal regulations.

After unpacking, inspect the apparatus for:

- damage in transit
- completeness of the delivery (compare delivery note)

If you notice any deviants, please *immediately* inform the hauler and the [manufacturer](#). **Do not** put the RepRap Industrial to use with defective parts.

## Transport

To avoid injuries and property damage observe the following notes when transporting the RepRap

Industrial:

- The apparatus' weight exceeds 50 kg. Always carry it **two by two**.
- Keep the RepRap Industrial horizontal to avoid damaging internal parts.
- Avert shock loads to the housing.

The RepRap Industrial has been designed for stationary application. It is not equipped with special transport devices such as lifting eyes or handles. The feet provide sufficient clearance to lift the apparatus and carry it to the installation site.

While the RepRap Industrial is packed and on its transport palette, use a lifting cart or pallet stacker for transportation. Make sure that the weight is evenly distributed and secure the RepRap Industrial against tilting.

#### INFO



*The housing is not designed for subsequently attaching lifting eyes. If you need to transport the 3D printer longer ways, load and secure it on a stable pallet and transport it with a pallet stacker or lifting cart.*

*Detailed information about safeguarding and packing the 3D printer for shipping can be found in the [Service Guide](#).*

## Storage

If the RepRap Industrial must be stored away, choose a leveled storage site and make sure that the 3D printer does not stand on a ledge.

Before storing it, clean the RepRap Industrial and protect it from dust with a plastic tarpaulin or air cushion foil.

#### NOTICE

*Do not cover the 3D printer with a textile sheet since the fibers may enter the supply system and clog the nozzles after recommissioning. Use lint-free plastic sheets only.*

The storage ambient conditions for the RepRap Industrial and its components are stated in the [data sheet](#). For recommissioning after lengthy periods of storage follow the information given in [initial commissioning](#).

## Environment, recycling and disposal

When used as intended, the RepRap Industrial presents no environmental danger.

However, the internal cooling works with a coolant that can be environmentally dangerous when leaking (see [data sheet](#)). Please observe the manufacturer's safety data sheet when handling the coolant.

The materials used for printing can also be environmentally dangerous when handled improperly. Always observe the manufacturer's safety data sheet and process plastics only within the limit values

specified therein and with respect to the safety instructions.

**Generally, consider the environment:** the auxiliary and operating materials of the RepRap Industrial can be dangerous to environment and health.

Awareness and foresighted behavior help avoiding ecological and personnel damage.

Components may bear valuable elements such as rare earths, or may be reusable. Do not waste them by inadequate and thoughtless disposal.

Environmentally hazardous substances **must not** trickle into the soil or enter the sanitation. They must be stored in suitable containers and be disposed off adequately and in accordance with local and national regulations.

The RepRap Industrial is recyclable due to its low-pollution equipment. Nonetheless, the European Guideline 2002/96/EG (Waste Electrical and Electronic Equipment - WEEE) and the German *Elektro- und Elektronikgesetz* (ElektroG) forbid the disposal of the apparatus via the household garbage. For environmental friendly recycling and disposal of the RepRap Industrial please contact a certified electronic waste management professional.



#### INFO

*Kühling&Kühling emphasize that there is no redemption obligation in this regard.*

## EU declaration of conformity

Valid [EU declaration of conformity](#) for reference.

## Personnel safety and device reliability

The RepRap Industrial features state-of-the-art design and construction and has been built and tested thoroughly so that it is safe and ready to use at delivery. Nonetheless, hazardous situations may appear due to the production process itself and property damage may be caused by false operation.

### The risk of experiencing hazardous situations is increased by:

- Using the RepRap Industrial for other applications than the intended.
- Inappropriate usage of the 3D printer.
- Operating the 3D printer in a non-safe state or under improper conditions.
- Insufficient attention, lax handling or intensive soiling.

### Therefore:

- Use the RepRap Industrial for its **intended use only**.
- The RepRap Industrial must be in good working order and in a safe state at any



#### INFO

*The manufacturer cannot be held liable for injuries and damages due*

time. Check the apparatus prior to every commissioning and at regular intervals for wear, damage and cleanliness.

- Ensure that nobody can be injured by parts of the 3D printer.
- Fix any error condition or visible damage immediately. If prompt rectification is impossible, decommission the 3D printer and do not put it back to use unless all problems have been solved.
- Regard the local accident prevention regulation.
- Provide access to the operating manual for anybody operating the machine.



*to inappropriate usage of the RepRap Industrial.*

*Inappropriate usage of the RepRap Industrial voids the manufacturer's warranty.*

## Injury risks

Some hazards are design related and cannot be avoided by mere constructive measures. To avoid injuries it is necessary that the operator is aware of such situations and takes adequate care. The owner has to make sure that the safety precautions are observed.

The safety advices given in the following are meant to protect the operator of the RepRap Industrial. It is the owner's responsibility to ensure that anybody working with or on the 3D printer is familiar with this chapter and observes the given information.

## Electrical safety

The RepRap Industrial is operated with 110 to 230 V (DC). Touching current-carrying parts can be **life-threatening** and cause **severe injuries**.

- Only connect the 3D printer in accordance with the specifications given in the [data sheet](#).
- Works on the electrical equipment of the RepRap Industrial and on the power supply system may **only** be carried out by skilled electricians.
- Always disconnect the 3D printer from the power supply by switching the main switch off and removing the mains plug from the socket before carrying out maintenance, repair or cleaning.
- Check the condition of cables and isolations at regular intervals and replace damaged parts immediately.
- Do not setup and operate the 3D printer in a humid environment.

## Hot surfaces

Outer surfaces of the RepRap Industrial are adequately isolated and do not exceed temperatures of +40°C (104°F). They are safe to the touch at any time.

Inside the build chamber, the heating elements generate the necessary ambient temperature for warp-free printing. Depending on the processed material, surfaces inside the build chamber can **reach temperatures up to +70°C (158°F)**.



The print table is heated separately, also to minimize warpage. It can **reach temperatures up to 130°C (266°F)**.

The extruder nozzles are heated to melt the filament strands and may **exceed temperatures of 300°C (572°F)**.

Do not open the build chamber during or immediately after completion of a print job. The print table heating shuts down after finishing a print and cools down to chamber temperature. **Always wait** at least 10 minutes before removing the printed object. This is also to avoid stress cracks due to sudden temperature drop.

If, for reasons of avoiding damage (e.g. collisions), it becomes necessary to interrupt the printing process and to open the build chamber before the cool down time has passed, **wear adequate protective gloves** when touching any interior.

## Coolant

For proper operation the RepRap Industrial is equipped with a closed loop low-maintenance cooling system that needs little interference. The circuit is filled with coolant type *Innovatek Protect IP ready-to-use*.

If it is necessary to perform works on the cooling system, such as refilling coolant or exchanging defective hoses, avoid direct skin or eye contact. Always wear **adequate protective gloves** that are resistant to chemical substances (e.g. PVC, NBR).

Observe the information provided in the manufacturer's safety data sheet. Additional information concerning the cooling system and required maintenance can be found in the [Service Guide](#).

## Emergency stop

You will find a red **Emergency STOP** button in the top-right corner of the touchscreen. In case of any unexpected performance of the 3D printer, press this button to immediately stop any mechanical movement in the build chamber and to shut down all heater elements.

### NOTICE

The emergency stop function does not provide a cool down sequence. Do not use the emergency stop button to abort current print jobs, because this may lead to damage of the 3D printer due to uncontrolled heat accumulation.

Do not use the main switch as an emergency stop button. You risk losing or corrupting data.

When the emergency stop is triggered, the microcontroller board responsible for the stepper motors, heaters and sensors is reset immediately and returns to idle state afterwards. Now it is safe to resolve any problems or defects in the build chamber.

The build chamber can then be reactivated via the [\[Print\]](#) menu.  
Detailed information are provided in the [Operating manual](#).

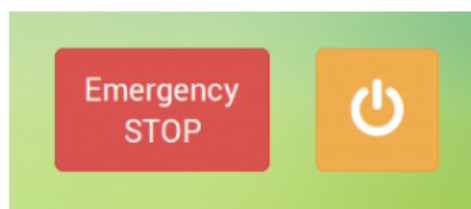

The emergency stop button in the top-right corner of the GUI will immediately stop all movement and set the 3D printer in a safe state for troubleshooting.



## Operator qualification

Operating and service personnel must be familiar with the information provided in the manual. Special training and qualification are not required for operating the 3D printer. Works on the electrical equipment and connections of the 3D printer require profound knowledge of electrics and electronics.

## Personal protective equipment

During normal operation it is not necessary to wear special protective gear. Some tasks however should not be performed without taking protective measures. Situations that require protective equipment are specially indicated. It is the owner's obligation to provide adequate protective equipment.

## Product reliability

False handling of components can lead to loss of production due to property damage; therefore we strongly recommend following the information given in this manual.

## Extruder nozzles

The brazen extruder nozzles are sensitive to heat treatment and mechanical strain. If the nozzles or extruder barrels are clogged by congealed material, reheating during the normal production flow is utterly sufficient to clear them in most cases. In case you want to change the material type or clogging is effected by foreign particles (i.e. dust grains dragged along with the filament), it is necessary to remove congealed material from the nozzles. The corresponding description can be found in the [cleaning recommendation](#).

### NOTICE

*Do not use mechanical tools or open flames to remelt or remove residues in the nozzles. Overheating may induce easing of tensions and deformation. The nozzle is then no longer usable for printing.*

## Structural and functional description

No.	Description
1	<a href="#">Build chamber</a>
2	<a href="#">Electronic chamber</a>
3	<a href="#">Touchscreen</a>

The following paragraphs name and explain all components of the RepRap Industrial to give you an exact overview. The terms are used consistently throughout this manual and will

help you identifying any part you may wish to find or order as a spare part.

The RepRap Industrial is built on an alloy framework and is mainly divided into two chambers. The upper **build chamber** is covered with acrylic glass plates to provide insight during production. It contains all mechanical components. At the back cover, the **filament supply** is installed.

The lower **electronic chamber** is covered with opaque plastic plates and contains the electronic components and the mains adapter. All connections and the power switches are located here and the **touchscreen** for operation is mounted at the front cover.

All covers are fixed to the frame with M4x20 hexagon socket screws and hammerhead nuts, thus being easy **to remove** and making all around access possible to all parts if required.

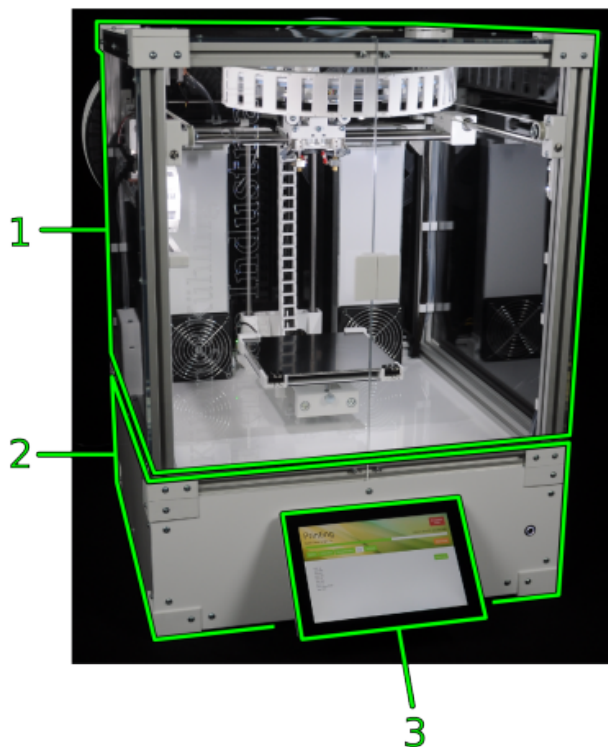

General overview of the RepRap Industrial 3D printer.

All references concerning directions are defined throughout this manual as follows:

Tag	Aspect	Description
<b>F</b>	Front	Standing in front of the 3D printer's touchscreen and looking inside the build chamber. This is the reference view for all other directions.
<b>L</b>	Left	Left side of the 3D printer, referred to the frontal view.
<b>R</b>	Right	Right side of the 3D printer, referred to the frontal view.
<b>B</b>	Back	Backside of the 3D printer, referred to the frontal view

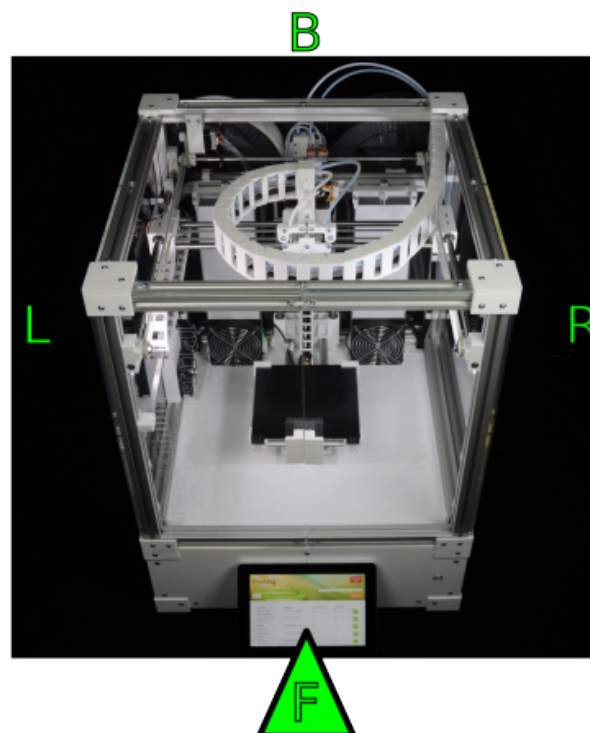

Directions and aspects of the 3D printer. All statements refer to the frontal view.

All movement directions of the axes are defined throughout this manual as follows:

Tag	Called	Movement direction
X⊕	X positive	Extruder head moves to the right.
X⊖	X negative	Extruder head moves to the left.
Y⊕	Y positive	Extruder head moves backwards.
Y⊖	Y negative	Extruder head moves forward.
Z⊕	Z positive	Print table moves down.
Z⊖	Z negative	Print table moves up.

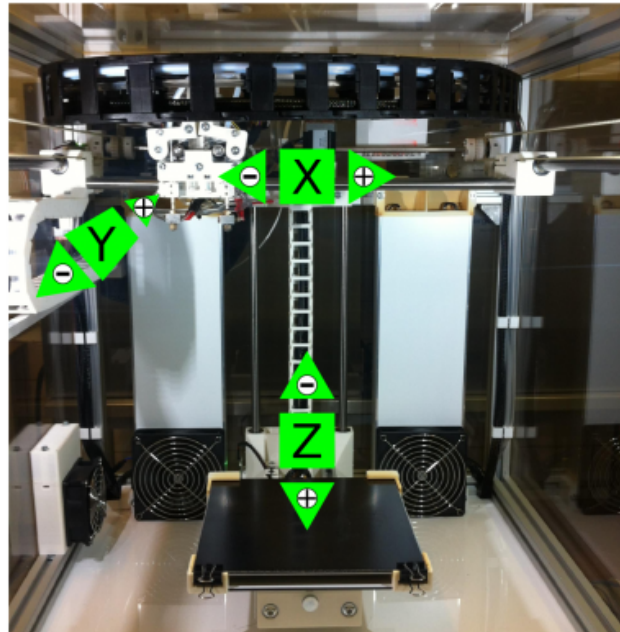

Denotation and direction determination of the axes.

All movements of the extruder drives are defined throughout this manual as follows:

Tag	Called	Movement direction
⊕	extrude	Left extruder → counter-clockwise rotation Right extruder → clockwise rotation
⊖	retract	Left extruder → clockwise rotation Right extruder → counter-clockwise rotation

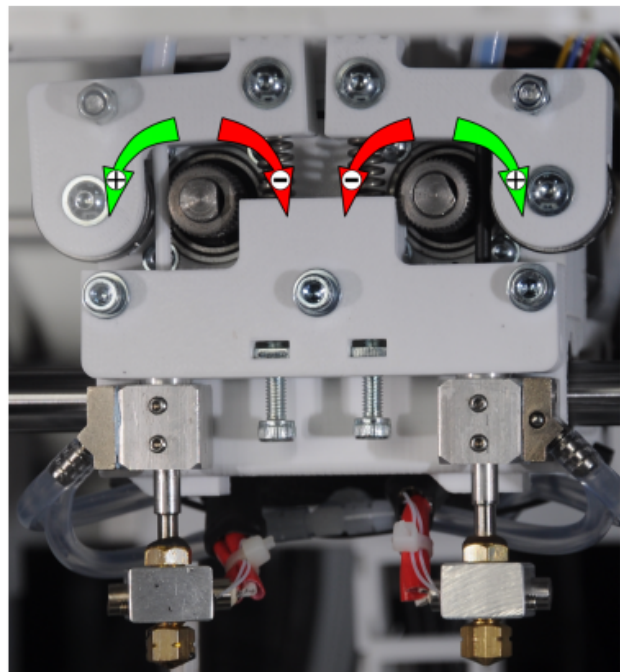

Movement directions of the extruder drives.

## Build chamber

No.	Description
1	Extruder head
2	Print table
3	Heating elements (covered) and fans
4	Activated carbon filter with fan

The build chamber is the main production area with the vertically moving [print table](#) and the

two-directional horizontally moving extruder head inside.

All [electrical motors](#) are installed at their working point and equipped with a water cooling system. The [extruder head](#) moves on an H-frame, tooth-belt-driven by two separate stepper motors in X- and Y-direction. The [print table](#) is lifted and lowered in Z-direction by a spindle drive.

For regulating the temperature inside the build chamber two heating resistors in separate housings heat the air which then is circulated through the chamber by the fans.

Cables and hoses are installed in and guided by cable carriers.

To minimize air pollution from dissolved substances, an additional fan circulates the air through a filter element filled with granules of activated carbon.

The access to the build chamber is the magnetically closed double door at the front.

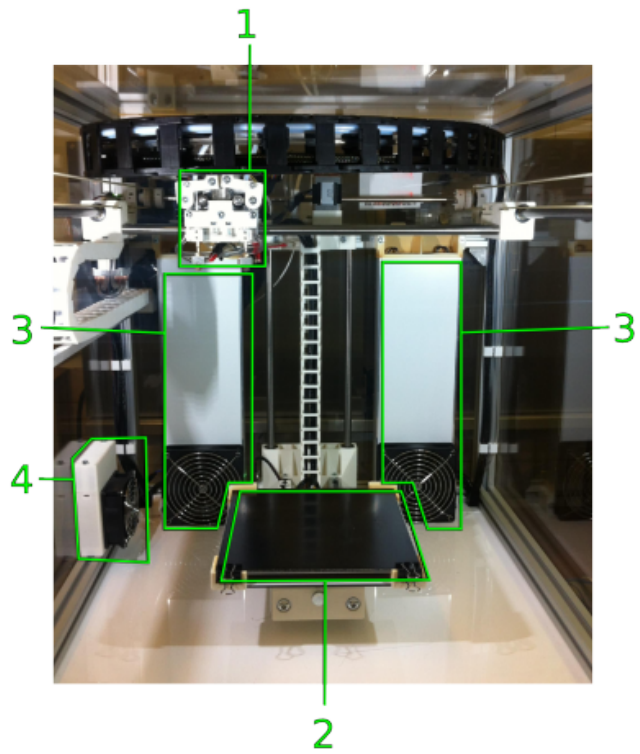

Inside view of the build chamber.

No.	Description
5	Filament supply

The filament spools that provide the necessary material are installed at the rear of the build chamber next to the [filament feed unit](#).

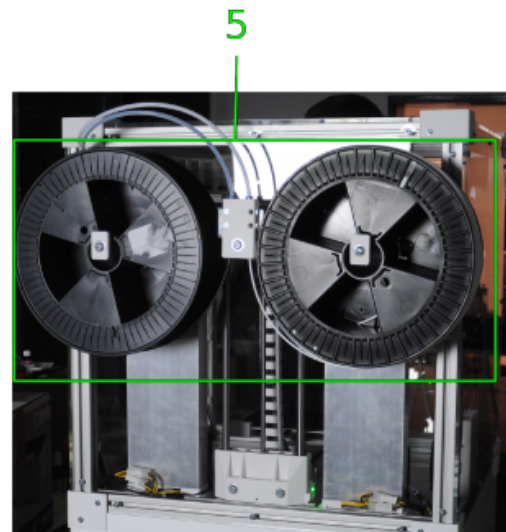

Filament supply unit at the rear side of the build chamber.

## Extruder head components

No.	Description
1	Carriage
2	Left (primary) hot end for standard single extruder prints (see <a href="#">9 - 19</a> )
2a	Right (secondary) hot end for dual extruder prints (multi-color or multi-material)
3	Filament drive gear



No.	Description
4	Idler lever (release function)
5	Spring tensioning screw M4x20
6	Idler spring
7	Filament feed hose
8	Cooling hoses

The extruder head is mounted to the traverse of the H-frame and moves horizontally in X- and Y-direction with useful operating ranges of  $X = 200$  mm and  $Y = 185$  mm.

It contains the filament drive gears forwarding the filament strands and the hot ends which melt and dose the material onto the [print table](#). The filament is supplied through a hose from the [filament supply](#) and is clamped between the idler lever and the filament drive gear. The filament drive gear is rotated by the [filament feed motor](#) and thereby forwarding the filament strand.

Each hot end is provided with its own filament strand, thus enabling bicolored prints, printing two materials or two objects simultaneously or printing with different extrusion thicknesses (e.g. for outer contours and inner filling structures). The left (primary) hot end is configured for standard single-extruder prints and is the reference nozzle for leveling the print bed. The right hot end is only leveled passively **after** the print bed has been aligned correctly with the primary hot end.

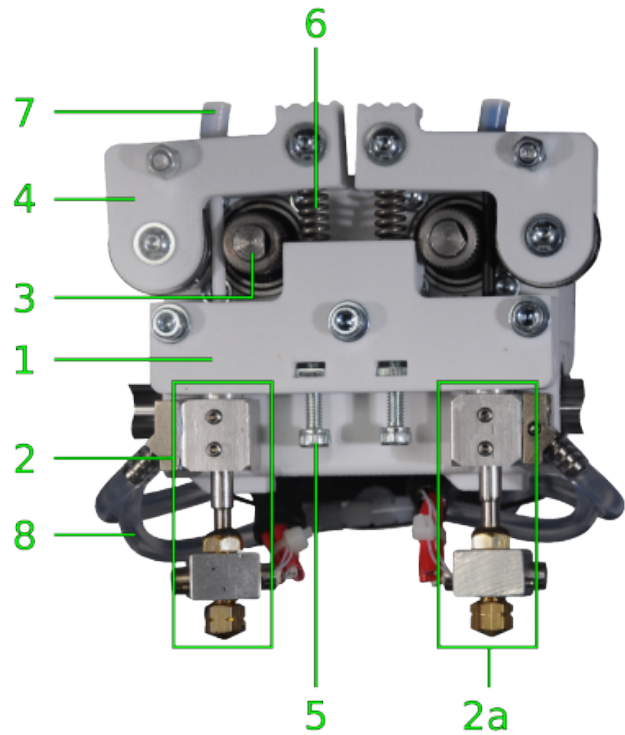

Extruder head components

No.	Description
9	Hot end mount (cooling block) with barrel set screws M3x6
10	Cooling hose adapter
11	Barrel
12	Melter
13	Nozzle (0.35mm preinstalled at delivery)
14	Heater
15	Heating resistor
16	Heating block set screw M3x6
17	Thermistor cables (thermistor sunken into heating block)
18	Heating resistor cables
19	Thermistor/Heating resistor cable connections

The hot ends are heated by heating resistors so that the filament is molten inside the nozzle.

To improve the thermal control of the melting process the nozzle seats are connected to the cooling system. The cooling ensures an even temperature distribution in a well defined area of the nozzles so that there is a preheating zone and a melting zone.

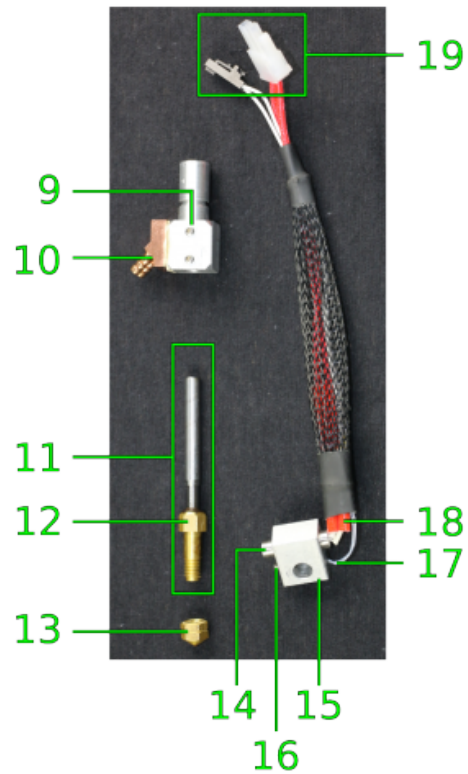

Hot end disassembled

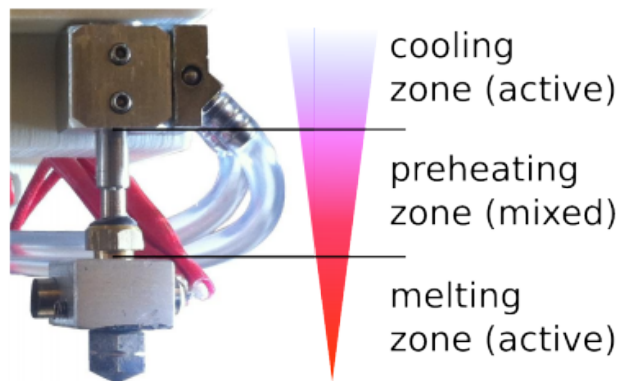

Temperature distribution inside the hot end.

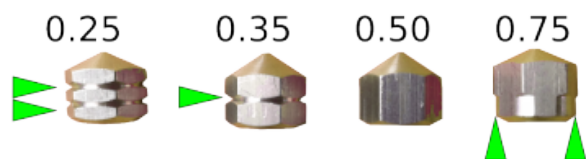

Markings to distinguish nozzle sizes.

The nozzle is **exchangeable** to provide different bore diameters for different materials, layer thicknesses or print speed. Ex factory, the 0.35mm tip is preinstalled. Additionally, three nozzles with diameters of 0.25mm, 0.5mm and 0.75mm are included. The tips are distinguishable by the engraved markings.

INFO



The 0.35mm and the 0.5mm nozzles should be used for most purposes and can be driven with an extrusion speed of up to 60mm/s. The Slic3r profiles that you install during initial commissioning are optimized for the 0.35mm

nozzle. Additional information can be found in the [Service Guide](#) and in the *Slic3r* manual. Please try and find the settings best suited for your task. Updated and extended *Slic3r* profiles will be available soon. The 0.75mm nozzle is primarily intended for experimental usage and should only be used with a max. extrusion speed of 20mm/s for a start. Adjust the extrusion speed stepwise until optimized for your needs.



The 0.25mm nozzle is for filigree, thin walled extrusions. Do not exceed an extrusion speed of 35mm/s since the material throughput will not suffice for higher speeds.

## Print table and print bed

No.	Description
1	Elevator assembly
2	Heated print table
3	Removable 2.5 mm PEI print bed (hardware revision 1.0.0)
4	Bulldog clamp (2 in hardware revision 1.0.0)
5	Set screws of 3-point leveling support
6	Removable 1.8 mm PEI print bed (hardware revision 1.1.0)
7	Bulldog clamp (4 in hardware revision 1.1.0)

The print table is mounted on the elevator assembly on a 3-point leveling support with set screws, so that the print bed can be height-adjusted for an even and accurate leveling. It is positioned accurate to the millimeter in Z-direction in its useful operating range of 280 mm by the [spindle motor](#). Heating is provided by a flat heating resistor to provide optimal adhesion and even temperature distribution throughout the printing process.

To perform leveling, start the [Print Bed Leveling](#) wizard which will guide you through the process step by step. Additional information on leveling can be found in the [Knowledgebase](#).

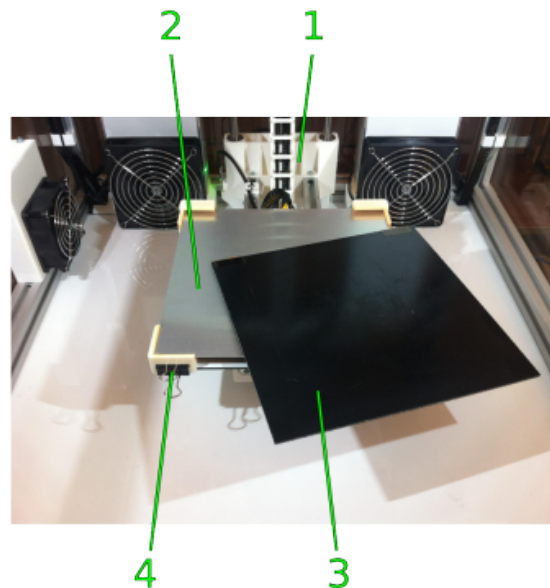

Print table and print bed fastened with two bulldog clamps (hardware revision 1.0.0).



The print itself will be executed on the polyetherimide (PEI) print bed laid on the print table and fixed with bulldog clamps. In hardware revision 1.0.0 (find the valid hardware revision of your 3D printer on the [type plate](#) the 2.5 mm print bed is held down by two fixedly mounted downholders and two bulldog clamps. With hardware revision 1.1.0 a new, thinner (1.8 mm) print bed is delivered. This could be realized due to the use of other fabrics and provides a more uniform temperature distribution at increased stiffness. The downholders have been replaced with two additional bulldog clamps to allow the use of print beds of different thicknesses. The print bed can be exchanged for every print, thus minimizing interruption times during production.

### Important print bed knowledge

The PEI glass fabric composite print beds are, in accordance with the RepRap Industrial's standards, optimized for printing ABS and are custom-made to Kühling&Kühling specifications. Due to the manufacturing process, they may show bends and curves which can make handling them a bit tricky. These flaws are accepted due to the superior properties of PEI compared to other subsurfaces when printing ABS. It also works fine with HIPS, PET-Copolyester, PVA and thermoplastic urethane (TPE-U). Other materials may require a different subsurface, be it another material or a special treatment with tape or glue.

PEI is highly resistant to a lot of solvents which makes it a suitable subsurface for a lot of materials since removing residues and refurbishing for the next print becomes quite easy.

Find more information about the custom-made Kühling&Kühling PEI print bed:

- Operating and handling are described in the [Operating manual](#).
- Cleaning and care can be found in the [Service guide](#).
- Read about materials and printing subsurfaces in the [Knowledgebase](#).

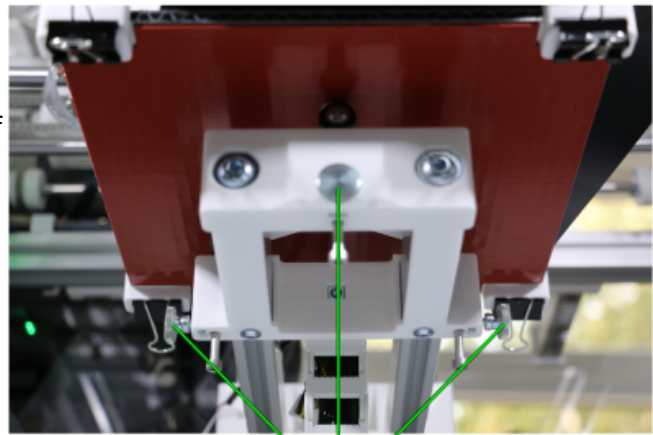

5  
3-point leveling support

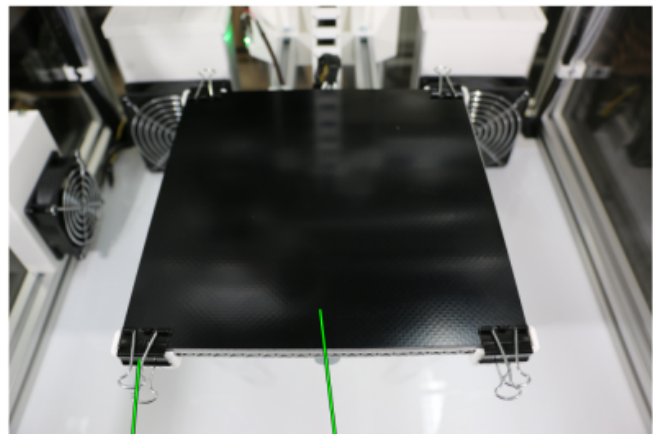

6  
7  
Print bed fastened with four bulldog clamps (hardware revision 1.1.0).

## Drives

No.	Description
1	X-axis motor (extruder head motor)
2	Y-axis motor (H-frame traverse motor)
3	Z-axis motor (spindle drive of <a href="#">print table</a> )
4	Filament feed motors ( <a href="#">filament gear drive</a> )

Five electrical stepper motors, one per direction of the [extruder head](#), one for lifting and lowering the [print table](#) and one per [extruder head nozzle](#) for forwarding the [filament](#), provide all necessary movement for printing. All motors are equipped with water cooling to prevent overheating due to workload and the heating of the [build chamber](#).

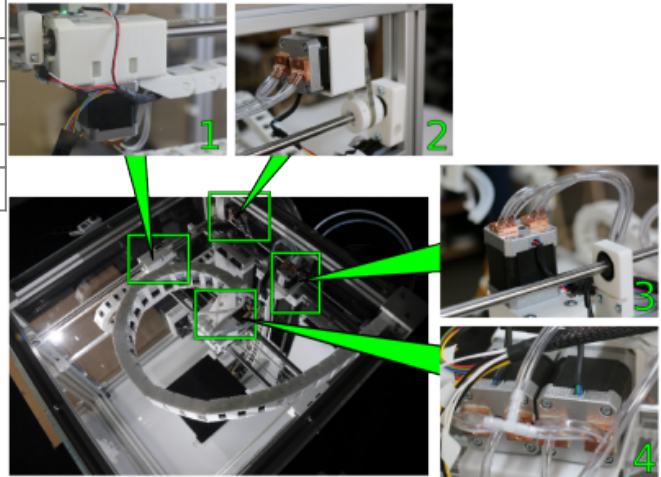

Single views of the drive motors.

## Sensors

Sensors for positioning and temperature control are installed inside the build chamber.

Every axis is equipped with a Hall effect sensor and a magnet for accurate home positioning. If the Hall effect sensor nears the magnet and measures the defined threshold value of the magnetic field strength, the sensor effects a "stop" signal via the microcontroller. After all sensors have given this signal the moving axes are in home position. The home position is the reference value for all relative movement of the extruder head and the print bed.

Temperature sensors (thermistors) measure the relevant temperatures for the printing process, i.e. the extruder temperature, the print bed temperature and the build chamber temperature. All thermistors deliver their input signal to the microcontroller and thus effect switching on and off the according heating resistor.

The extrusion temperature is measured at the [heating block](#) near the heating resistor and the relevant values for the control of the latter.

The print bed temperature is measured directly at the heating pad with which it is looped in a control circuit.

The build chamber sensor is installed at the elevator assembly and measures the air temperature inside the build chamber. Its

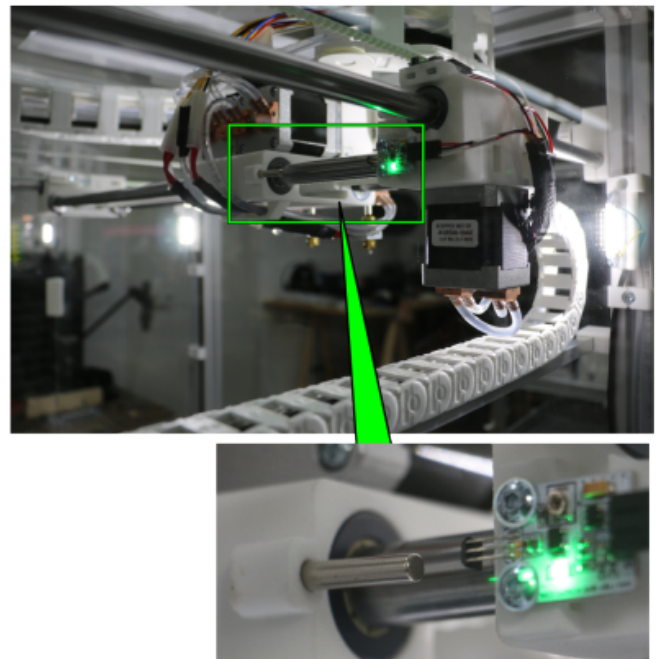

Hall effect sensor and magnet of the X-axis.

measurements influence the control of the heating resistors inside the [heating elements](#).

A limit switch is installed at every filament inlet of the filament feed unit (see [below](#)).

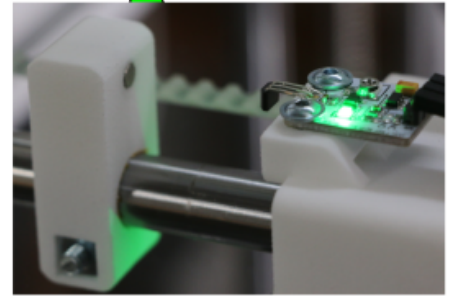
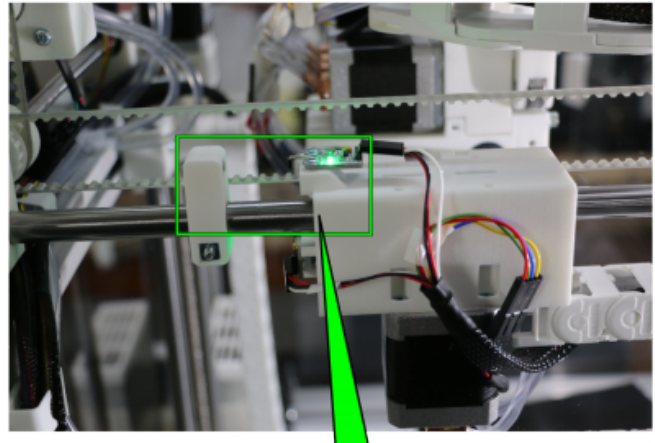

 Hall effect sensor and magnet of the Y-axis.

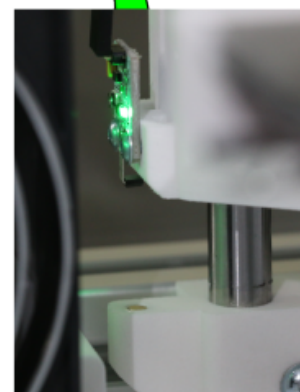
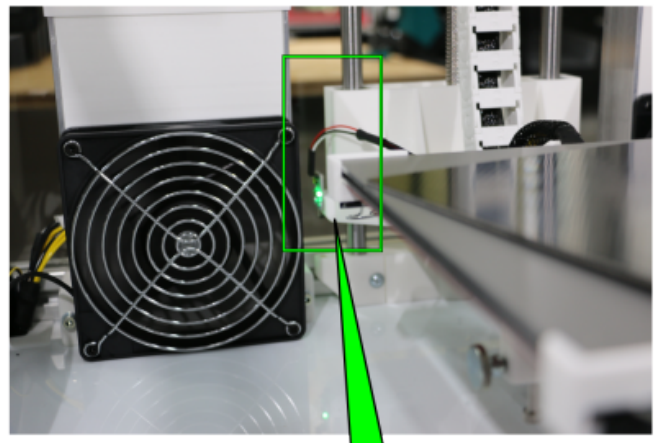

 Hall effect sensor and magnet of the Z-axis.

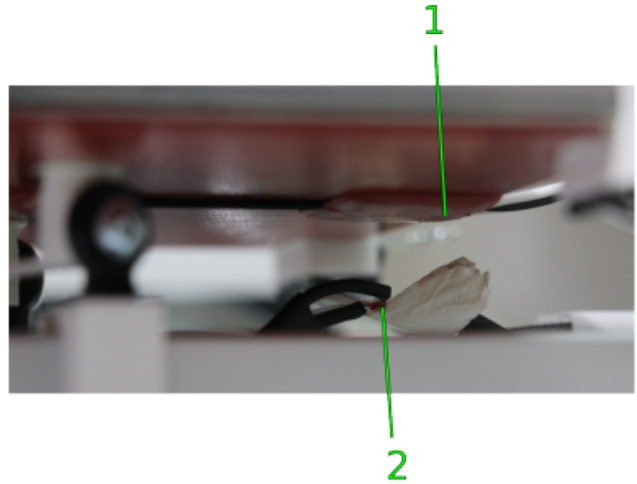

Thermistors of the print bed (1) and the build chamber (2).

## Filament supply

No.	Description
1	Feed unit
2	Filament spool carrier
3	Filament spool (2.3 kg)
4	Limit switch
5	Filament inlet with dust wiping sponge

The RepRap Industrial is designed for printing filament strands of a diameter of 2.85 mm with a tolerance of  $\pm 0.1$  mm. More information about filament and materials can be found in the [material section](#) and the [print preparation section](#) of the [Knowledgebase](#).

Two separate strands can be fed from the outside to the extruder head. One filament spool can be positioned on each spool carrier; a stop collar prevents them from falling down due to their rotation.

The end of the filament strand is manually inserted into the inlet of the feed unit and led through hoses to the two [extruder nozzles](#). At the inlet the filament is put through a sponge that wipes dust off the strand to keep the material unsoiled before reaching the nozzle. A limit switch registers the end of the filament strand when the spool is empty. The print process then is interrupted and the lack of material is signaled on the [touchscreen](#). The printing process can be resumed after [refilling](#) the supply.

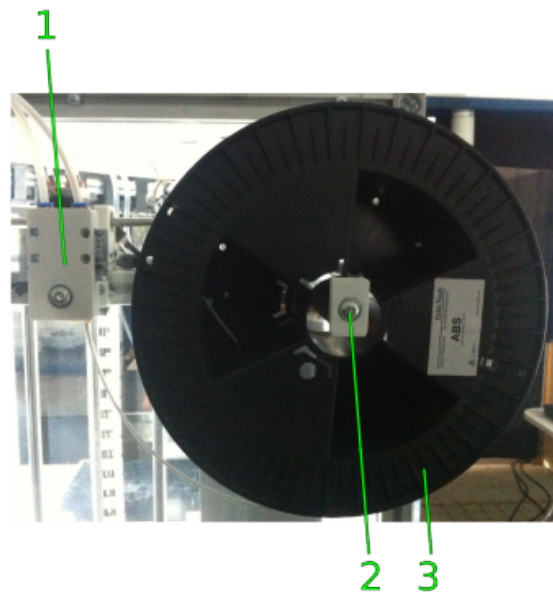

Filament supply

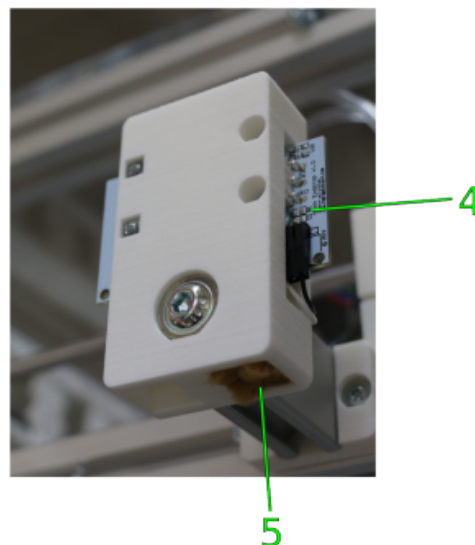

Filament inlet with limit switch and dust wiping



sponge.

## Wiper

No.	Description
1	Wiper lip
2	Bracket
3	Excess retainer
4	Mounting arm

Since hardware revision 1.3.0 the RepRap Industrial 3D printer can be equipped ex factory with a wiper to enable high-quality [dual extruder printing](#).

If ordered as an upgrade kit click [here](#) to find the [installation instructions](#).

### INFO



When [requesting a quote](#) for the RepRap Industrial 3D printer please state whether the wiper shall be included or not.



Starting with hardware revision 1.3.0 the 3D printer can be ordered with the wiper preinstalled. It can also be ordered as a separate upgrade kit.

## Electronic chamber

No.	Description
1	MOSFET power switching boards
2	RUMBA board
3	BeagleBone Black embedded computer
4	LVDS-to-HDMI controller board (behind front cover panel)

All control elements are installed in the electronic chamber together with the 12 V(DC) mains adapter and the cooling unit.

The chamber is completely covered with plastic sheets fastened to the aluminum frame with hexagon socket screws and hammerhead nuts. The MOSFET power switching board consists of five MOSFETs that switch the four heating resistors of the [build chamber](#) heating and the heating resistor of the [print table](#).

The RUMBA board (also *reprap microcontroller*

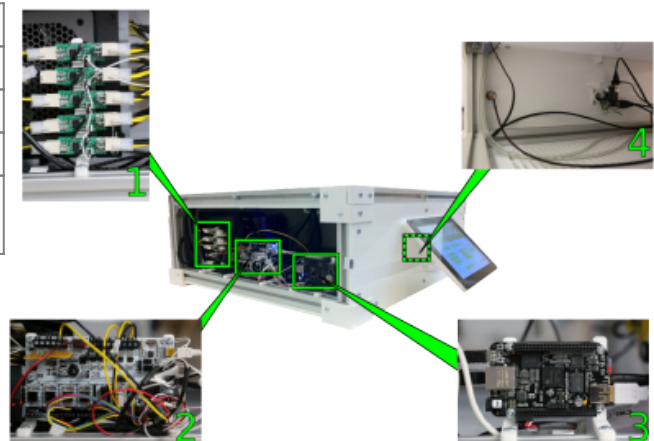

Inside view of the electronic chamber (left side).

board) controls all processes of the printing process, i.e. the drives, the heating resistors, heating fans and the temperature sensors. Exchangeable hardware components are the stepper motor drivers.

The BeagleBone Black embedded computer provides the GUI of the [touchscreen](#) and the ethernet connection and processes the G-codes of the slicing software.

Slots in the bottom cover provide an air inlet for the cooling unit.

No.	Description
5	Mains adapter
6	Cooling unit radiator
7	Cooling unit pump

The cooling unit consists of a pump with water reservoir, a radiator and the closed loop coolant circuit, which is filled with Innovatek Protect IP ready-to-use. The coolant is pumped in a circle past the [motors](#) and the [extruder nozzles](#) where it absorbs heat and is then cooled down by the radiator. The pump starts/stops automatically when the build chamber is switched on and off. How to judge if [refilling of coolant](#) is necessary and the necessary steps are described in the Service guide.

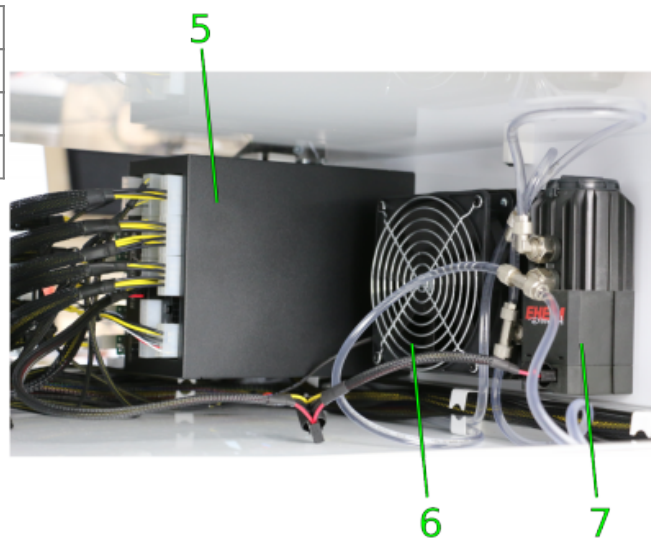

Inside view of the electronic chamber (right side).

No.	Description
8	Type plate
9	Cooling unit radiator grill
10	Mains plug
11	Main switch
12	RJ45 ethernet plug
13	230 V supply cable with Schuko plug

At the rear cover you find the mains plug and the main switch of the mains adapter and the RJ45 ethernet plug for the network connection.

The cooling systems' accumulated warmth is dissipated via the radiator grill to the outside. The [type plate](#) is positioned next to the fixing screws of the cooling water pump.



No.	Description
14	Touchscreen user interface (GUI)
15	Wake button

The wake button at the front panel provides a wake-up function and indicates the general operating status of the 3D printer. It is equipped with a light ring that is illuminated while operational and dims after the 3D printer has been shut down. Press the button to restart the 3D printer from standby.

 Rear cover

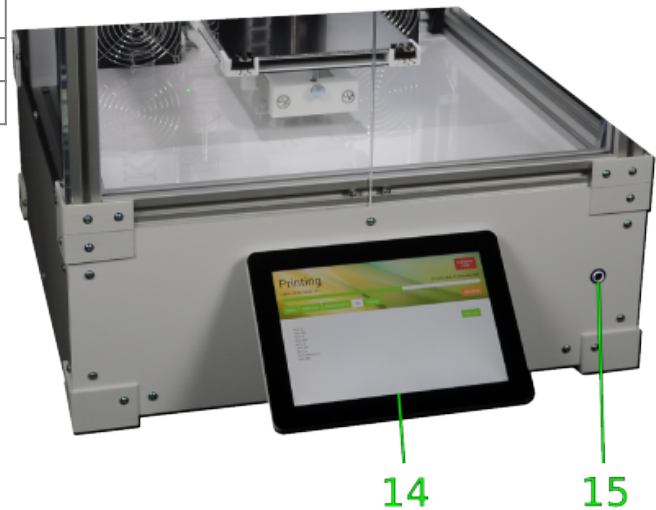

 Touchscreen user interface and wake button at the front cover.

## Touchscreen operation

Operating the RepRap Industrial is designed to be comfortable and intuitive. Therefore, a high-resolution 10" TFT touchscreen mounted at the front panel provides an easy-to-use Graphical User Interface (GUI).

All operation of the RepRap Industrial is carried out via the **RepRapOnRails** operating software which provides status messages and control functions that can be chosen by simply tapping the respective buttons. Find detailed explanations of functions and operating procedures in the [Operating manual](#).

In case you experience any trouble, please refer to the [Service guide](#) and [Troubleshooting](#). If you cannot solve a problem with the information given there, you are always welcome to [contact us](#) personally. We are trying to improve these information constantly and will be grateful for your help when you encounter any previously undescribed faults or problems.



 The high-resolution 10"-TFT touchscreen mounted at the front panel enables direct operation of the RepRap Industrial.

### INFO

 If you have a RepRap Industrial 3D printer of [Hardware revision 1.0.0](#) (check [type plate](#)) still running **in delivery condition** software version v1.0.5 is installed. In this case, operation is slightly different and described in [Software version v1.0.5 manual](#).

To update your 3D printer to a current version of the operating software refer to [upgrades](#)





description.

The currently installed version

of the operating software is displayed on the right-hand side of *Setup* menu together with additional system information.



RepRapOnRails software version displayed in the *Setup* menu starting with version 1.1.0.

## Setup and Installation

Use a lifting carriage to bring the RepRap Industrial on its transport pallet as near to its setup site as possible. Before setting up the RepRap Industrial remove the lid and side walls of the transport box and all straps. Subsequently, lift the apparatus off the transport pallet **two-by-two** and carefully carry it to its final installation location.

## Installation requirements

### NOTICE

*The apparatus must not be set up in a surrounding with high formation of dust (e.g. near woodworks etc.). Ingress of particles into the filament supply system can lead to intense cleaning efforts due to clogging of the nozzles and thus immense non-productive time.*

Set up the RepRap Industrial at a well aerated place with an all-season ambient temperature between 15 and 25°C and a relative humidity of 70%.

Position the RepRap Industrial on a flat, carrying and enduring surface with a load capacity of at least 75 kg.

To ensure unhindered aeration of the electronic chamber no soft, movable materials (e.g. table cloth, cardboard strips, paper etc.) may be placed underneath the apparatus to prevent clogging of the vent slots.

The required setup space must at least be 650 x 650mm and provide approximately 500mm free space to either side to enable unhindered access

to the electronic chamber for service and maintenance work. At least 750mm free space must be left at the back of the RepRap Industrial to make changing the material easy and to ensure free air circulation at the ventilation grill in the back cover. At the front a free space of 1.250mm is recommended to allow easy operation with open chamber doors. To easily access the touchscreen in a sitting or standing position the height of the setup table should not undercut 780mm. A 230V power source must be within the range of the connection cable.

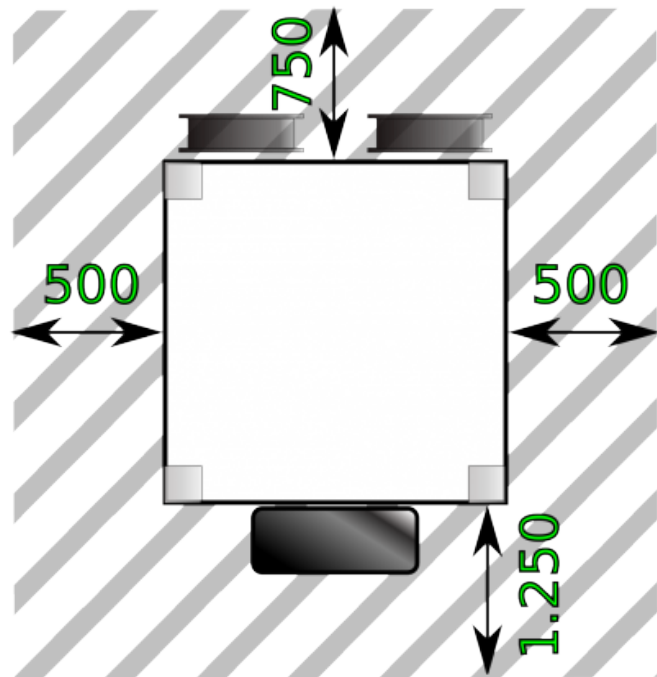

Necessary free space around the RepRap Industrial.

## Unpacking the machine

### **DANGER OF CUTTING INJURIES AND EYE DAMAGE!**

The packing straps are pretensioned and may whip when cut, causing cutting injuries or eye damage.

- Hold down the top part of the strap and cut it at the side. Make sure it does not hit somebody's face.

### **DANGER OF CUTTING INJURIES!**

The transport box is made of unfinished plywood and may hold splinters and sharp edges that can cause cutting injuries.

- Take care when removing the transport packaging and wear protective gloves.

### NOTE

If the 3D Printer has a temperature below 16°C (e.g. directly after delivery in cold weather) there is a danger of air humidity condensing on sensitive electronic components. This can lead to severe damages due to short circuiting during commissioning.

Therefore, it is necessary to let the 3D Printer warm up to ambient temperature at its operating place prior to commissioning.

Regard the [ambient conditions](#) required for operation.

To unpack the machine, cut the tensioning straps of the wooden transport box, remove the lid and carefully lift the box over the printer. Then cut the tensioning straps around the 3D printer and remove the wooden cover plate and the air cushion foil.

Set aside and store all parts of the transport packaging for later use, e.g. moving or shipping the 3D printer.



The wooden box and the lid are fastened to the pallet with tensioning straps.

The 3D printer is padded with air cushion foil and a wooden cover plate and strapped to the pallet with tensioning straps.

#### INFO



Find detailed information on repacking the machine for shipping in the [Service Guide](#).

## Removing the transport restraints

All moving components of the RepRap Industrial 3D printer are secured with blue tape against damage in transit.

Make sure all transport restraints named in the adjacent pictures have been removed before commissioning the 3D printer.

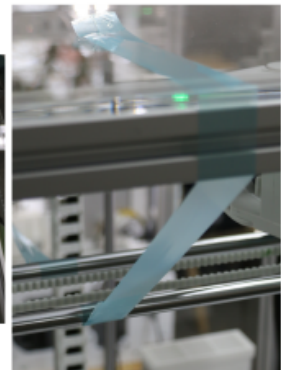
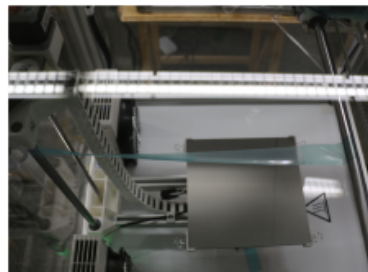

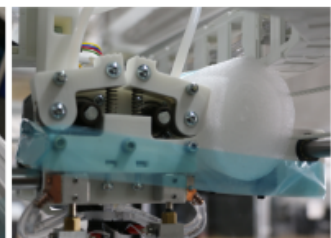
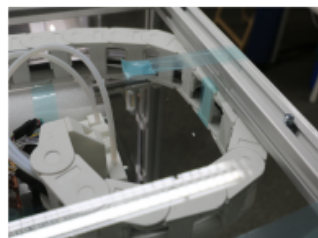

Transport restraint of the Y-axis: blue tape spans from the hind Y-shaft to the left Z-shaft and from the front Y-shaft to the top cover.



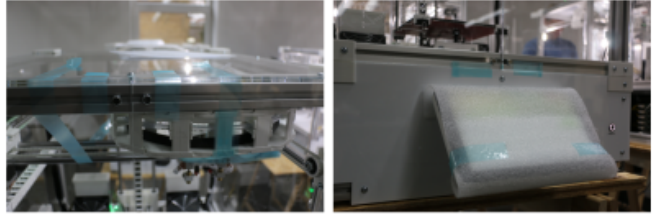

Transport restraint of the main e-chain: blue tape is strapped around the chain and fastened to the top cover.

Transport restraint of the extruder head: the extruder head is cushioned with air cushion foil and strapped to the right X-end with blue tape.

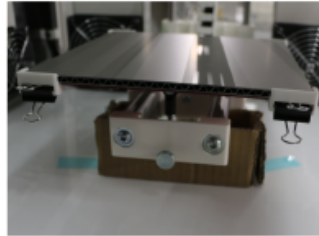

 The doors are held close by blue tape at the top and lower edge.  
The touchscreen is packed in air cushion foil.



 A cardboard frame supports the print table.

## Connections

After setting the apparatus up it must be connected to the power supply and the data network.

1. Set the power supply main switch at the back of the 3D printer to **<0>** (OFF).
2. Unpack the supply cable and connect it to the mains plug at the backside.
3. Connect the Schuko plug to a 230 V socket.
4. Connect the RepRap Industrial to your data network by plugging the network cable into the RJ45 ethernet plug. Your network must provide DHCP IP address management and should be connected to the internet (to enable the printer to fetch current time signal via Network Time Protocol (ntp)).

## Initial commissioning

After installation the further commissioning of the RepRap Industrial takes place at the web-interface and the touchscreen. Depending on the software version installed on your 3D printer, choose the according link:

- [software version v1.0.5](#)
- [software version v1.1.0](#)

[How do I find the correct software version?](#)

# Decommissioning

Decommissioning may be necessary on two occasions: the temporary decommissioning if the 3D printer will just be out of operation for a limited time (e.g. moving) or the permanent decommissioning if the 3D printer has expired its lifetime and will be scrapped.

## Temporary decommissioning

If you need to take the RepRap Industrial out of operation to move or store it, regard the following information:

- Remove remaining filament from the supply system.
- [Clean](#) the 3D printer, especially the extruder nozzles.
- Move all axes into their [home positions](#).
- Disconnect the mains cable and the network cable. Store them together with the 3D printer (e.g. fixed with adhesive tape inside the build chamber).
- Protect the print table surface and the touchscreen with a cardboard pad against scratching.
- Secure the extruder head, the print table, and the build chamber doors with strapping tape against moving (see [Transport](#)).
- Position the 3D printer on a transport pallet and cover it with a plastic tarpaulin or air cushion foil.

### NOTICE

*Do not cover the 3D printer with a textile sheet since the fibers may enter the supply system and clog the nozzles after recommissioning. Use lint-free plastic sheets only.*

- Use lashing straps to secure the 3D printer on the transport pallet.

## Permanent decommissioning

If you do not want to use the RepRap Industrial any longer or if it is damaged beyond repair:

- Take the RepRap Industrial out of operation as described [above](#).
- Drain the cooling system and collect the coolant. Dispose of the coolant according to your local guidelines and the manufacturer's data sheet.
- Disassemble all components according to their recyclability and dispose of them adequately and lawfully.

### INFO



*Components may bear valuable elements such as rare earths, or may be reusable. Do not waste them by inadequate and thoughtless disposal.*

# On demand maintenance

The RepRap Industrial 3D printer features a low-maintenance design, thus regular maintenance is not required during normal operation. [Regular cleaning](#) will mostly suffice to keep your 3D printer running satisfactorily. In case of faults, refer to the [troubleshooting guide](#) and the [Service Guide](#) where most problems known to us and according remedies are lodged.

## INFO



*If you encounter and/or solve problems nowhere to be found in the troubleshooting guide, you are welcome to inform us and we will gladly add your experience.*

## Imprint

*Jonas Kühling & Simon Kühling GbR  
Im Wiesengrund 23  
24113 Molfsee  
Deutschland  
E-Mail: [office@kuehlingkuehling.de](mailto:office@kuehlingkuehling.de)  
Tel.: +49 (0) 431 98 35 24 73*

*Handelsregister  
USt.-Ident.-Nr.: DE283006938  
WEEE-Reg.-Nr.: DE 11304600*

*Geschäftsführer  
Jonas Kühling  
Simon Kühling*